

# Model PAXLA - PAX Lite DC Volt/Current/Process Meter



- 5 DIGIT, 0.56" HIGH RED LED DISPLAY
- PROGRAMMABLE SCALING AND DECIMAL POINTS
- PROGRAMMABLE USER INPUT
- DUAL 5 AMP FORM C RELAY
- UNIVERSALLY POWERED
- NEMA 4X/IP65 SEALED FRONT BEZEL
- OPTIONAL CUSTOM UNIT OVERLAY W/ BACKLIGHT
- MINIMUM AND MAXIMUM DISPLAY CAPTURE



For Model No. PAXLA0U0 Only

## GENERAL DESCRIPTION

The PAXLA is a versatile meter available as a DC volt, current, or process meter with scaling and dual Form C relay outputs. The meter is programmed through the front panel buttons and the use of jumpers. The RST button can also function as a front panel display reset.

Once the front panel programming is complete, the buttons can be disabled by a user input setting. The meter has been specifically designed for harsh industrial environments. With a NEMA 4X/IP65 sealed bezel and extensive testing to meet CE requirements, the meter provides a tough yet reliable application solution.

## SAFETY SUMMARY

All safety regulations, local codes and instructions that appear in this and corresponding literature, or on equipment, must be observed to ensure personal safety and to prevent damage to either the instrument or equipment connected to it. If equipment is used in a manner not specified by the manufacturer, the protection provided by the equipment may be impaired.

**CAUTION: Risk of Danger.**  
Read complete instructions prior to installation and operation of the unit.

**CAUTION: Risk of electric shock.**

## ORDERING INFORMATION

MODEL NO.	DESCRIPTION	PART NUMBER
PAXLA	Volt/Current/Process Meter with Dual Relay Output	PAXLA000
PAXLA	UL Listed Volt/Current/Process Meter with Dual Relay Output	PAXLA0U0
PAXLBK	Unit Label Kit Accessory	PAXLBK10

## DIMENSIONS In inches (mm)

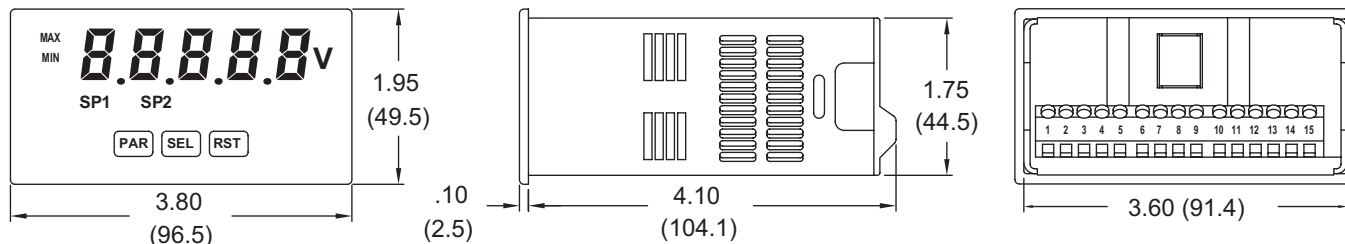

## SPECIFICATIONS

- DISPLAY:** 5 digit, 0.56" (14.2 mm) intensity adjustable Red LED (-19999 to 99999)
- POWER REQUIREMENTS:**  
 AC POWER: 50 to 250 VAC 50/60 Hz, 12 VA  
 Isolation: 2300 Vrms for 1 min. to all inputs and outputs  
 DC POWER: 21.6 to 250 VDC, 6 W  
 DC Out: +24 VDC @ 100 mA if input voltage is greater than 50 VAC/ VDC  
 +24 VDC @ 50 mA if input voltage is less than 50 VDC
- INPUT RANGES:** Jumper Selectable

**D.C. Voltages:** 200 mV, 2 V, 20 V, 200 V, 10 V

INPUT RANGE	ACCURACY @ 23 °C LESS THAN 85% RH	INPUT IMPEDANCE	MAX INPUT SIGNAL	RESOLUTION	TEMP. COEFFICIENT
200 mV	0.1% of span	1.033 MΩ	75 VDC	10 μV	70 ppm /°C
2 V	0.1% of span	1.033 MΩ	75 VDC	0.1 mV	70 ppm /°C
10 V	0.1% of span	1.033 MΩ	250 VDC	1 mV	70 ppm /°C
20 V	0.1% of span	1.033 MΩ	250 VDC	1 mV	70 ppm /°C
200 V	0.1% of span	1.033 MΩ	250 VDC	10 mV	70 ppm /°C

**D.C. Currents:** 200 μA, 2 mA, 20 mA, 200 mA

INPUT RANGE	ACCURACY @ 23 °C LESS THAN 85% RH	INPUT IMPEDANCE	MAX INPUT SIGNAL	RESOLUTION	TEMP. COEFFICIENT
200 μA	0.1% of span	1.111 KΩ	15 mA	10 nA	70 ppm /°C
2 mA	0.1% of span	111 Ω	50 mA	0.1 μA	70 ppm /°C
20 mA	0.1% of span	11 Ω	150 mA	1 μA	70 ppm /°C
200 mA	0.1% of span	1 Ω	500 mA	10 μA	70 ppm /°C

**D.C. Process:** 4 to 20 mA, 1 to 5 VDC, 0/1 to 10 VDC

INPUT RANGE	SELECT RANGE
4 - 20 mA	Use the 20 mA range
1 - 5 VDC	Use the 10V range
1 - 10 VDC	Use the 10V range



4. **OVERRANGE/UNDERRANGE INDICATION:**  
**Input Overrange Indication:** "OL OL"  
**Input Underrange Indication:** "UL UL"  
**Display Overrange/Underrange Indication:** "....."/"....."
5. **A/D CONVERTER:** 16 bit resolution
6. **UPDATE RATES:**  
 A/D conversion rate: 20 readings/sec.  
 Display update: 500 msec min.
7. **USER INPUT:**  
 User Input: Software selectable pull-up (24.7 KΩ) or pull-down resistor (20 KΩ) that determines active high or active low input logic.  
 Trigger levels:  $V_{IL} = 1.0$  V max;  $V_{IH} = 2.4$  V min;  $V_{MAX} = 28$  VDC  
 Response Time: 5 msec typ.; 100 msec debounce (activation and release)
8. **MEMORY:** Nonvolatile E<sup>2</sup>PROM retains all programming parameters when power is removed.
9. **OUTPUT:**  
**Type:** Dual FORM-C relay  
**Isolation To Sensor & User Input Commons:** 1400 Vrms for 1 min.  
 Working Voltage: 150 Vrms  
**Contact Rating:** 5 amps @ 120/240 VAC or 28 VDC (resistive load), 1/8 H.P. @ 120 VAC (inductive load)  
**Life Expectancy:** 100,000 minimum operations  
**Response Time:**  
 Turn On Time: 4 msec max.  
 Turn Off Time: 4 msec max.
10. **ENVIRONMENTAL CONDITIONS:**  
 Operating temperature: 0 to 50 °C  
 Storage temperature: -40 to 70 °C  
 Operating and storage humidity: 0 to 85% max. RH (non-condensing)  
 Vibration to IEC 68-2-6: Operational 5 to 150 Hz, 2 g.  
 Shock to IEC 68-2-27: Operational 30 g (10 g relay).  
 Altitude: Up to 2,000 meters

11. **CONNECTIONS:** High compression cage-clamp terminal block  
 Wire Strip Length: 0.3" (7.5 mm)  
 Wire Gage: 30-14 AWG copper wire  
 Torque: 4.5 inch-lbs (0.51 N-m) max.
12. **CONSTRUCTION:** This unit is rated for NEMA 4X/IP65 outdoor use. IP20 Touch safe. Installation Category II, Pollution Degree 2. One piece bezel/case. Flame resistant. Synthetic rubber keypad. Panel gasket and mounting clip included.
13. **CERTIFICATIONS AND COMPLIANCES:**  
**CE Approved**  
 EN 61326-1 Immunity to Industrial Locations  
 Emission CISPR 11 Class A  
 Safety requirements for electrical equipment for measurement, control, and laboratory use:  
 EN 61010-1: General Requirements  
 RoHS Compliant  
 UL Listed: File #E179259 **For Model No. PAXLA0U0 Only**  
 Type 4X Enclosure rating (Face only)  
 IP65 Enclosure rating (Face only)  
 IP20 Enclosure rating (Rear of unit)
14. **WEIGHT:** 10.4 oz. (295 g)

# 1.0 INSTALLING THE METER

## Installation

The PAX meets NEMA 4X/IP65 requirements when properly installed. The unit is intended to be mounted into an enclosed panel. Prepare the panel cutout to the dimensions shown. Remove the panel latch from the unit. Slide the panel gasket over the rear of the unit to the back of the bezel. The unit should be installed fully assembled. Insert the unit into the panel cutout.

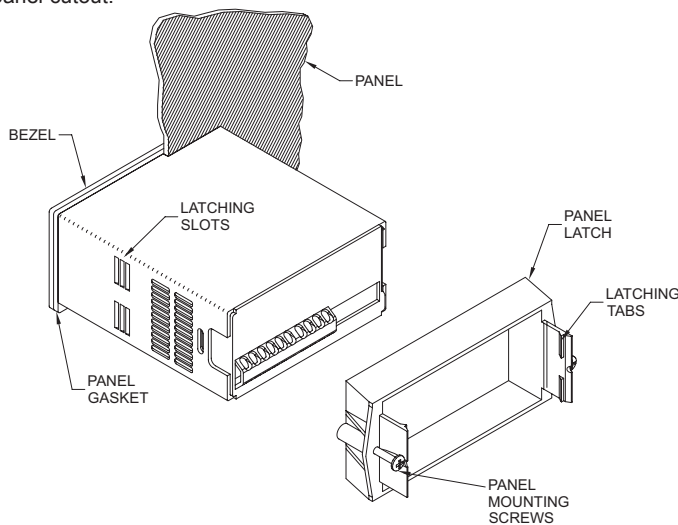

While holding the unit in place, push the panel latch over the rear of the unit so that the tabs of the panel latch engage in the slots on the case. The panel latch should be engaged in the farthest forward slot possible. To achieve a proper seal, tighten the latch screws evenly until the unit is snug in the panel (Torque to approximately 7 in-lbs [79N-cm]). Do not over-tighten the screws.

## Installation Environment

The unit should be installed in a location that does not exceed the maximum operating temperature and provides good air circulation. Placing the unit near devices that generate excessive heat should be avoided.

The bezel should be cleaned only with a soft cloth and neutral soap product. Do NOT use solvents. Continuous exposure to direct sunlight may accelerate the aging process of the bezel.

Do not use tools of any kind (screwdrivers, pens, pencils, etc.) to operate the keypad of the unit.

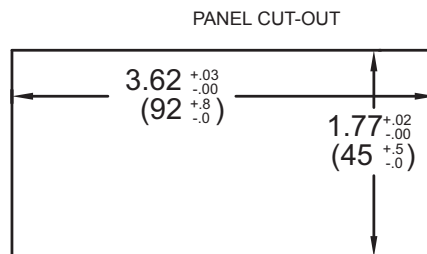

## 2.0 SETTING THE JUMPERS

### INPUT RANGE JUMPER

This jumper is used to select the proper input range. The input range selected in programming must match the jumper setting. Select a range that is high enough to accommodate the maximum signal input to avoid overloads.

To access the jumpers, remove the meter base from the case by firmly squeezing and pulling back on the side rear finger tabs. This should lower the latch below the case slot (which is located just in front of the finger tabs). It is recommended to release the latch on one side, then start on the other side latch.



**Warning:** Exposed line voltage exists on the circuit boards. Remove all power to the meter and load circuits before accessing inside of the meter.

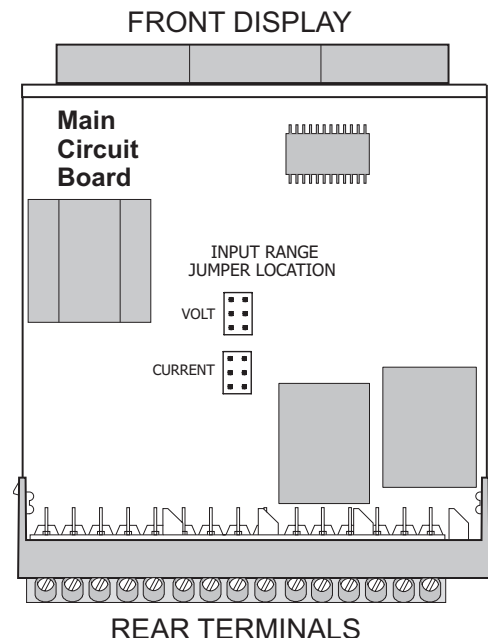
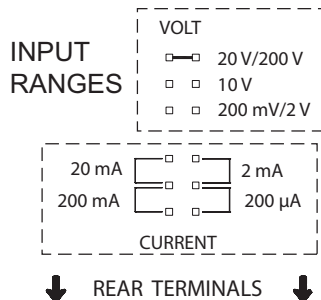

## 3.0 WIRING THE METER

### EMC INSTALLATION GUIDELINES

Although Red Lion Controls products are designed with a high degree of immunity to Electromagnetic Interference (EMI), proper installation and wiring methods must be followed to ensure compatibility in each application. The type of the electrical noise, source or coupling method into a unit may be different for various installations. Cable length, routing, and shield termination are very important and can mean the difference between a successful or troublesome installation. Listed are some EMI guidelines for a successful installation in an industrial environment.

1. A unit should be mounted in a metal enclosure, which is properly connected to protective earth.
2. Use shielded cables for all Signal and Control inputs. The shield connection should be made as short as possible. The connection point for the shield depends somewhat upon the application. Listed below are the recommended methods of connecting the shield, in order of their effectiveness.
  - a. Connect the shield to earth ground (protective earth) at one end where the unit is mounted.
  - b. Connect the shield to earth ground at both ends of the cable, usually when the noise source frequency is over 1 MHz.
3. Never run Signal or Control cables in the same conduit or raceway with AC power lines, conductors, feeding motors, solenoids, SCR controls, and heaters, etc. The cables should be run through metal conduit that is properly grounded. This is especially useful in applications where cable runs are long and portable two-way radios are used in close proximity or if the installation is near a commercial radio transmitter. Also, Signal or Control cables within an enclosure should be routed as far away as possible from contactors, control relays, transformers, and other noisy components.
4. Long cable runs are more susceptible to EMI pickup than short cable runs.
5. In extremely high EMI environments, the use of external EMI suppression devices such as Ferrite Suppression Cores for signal and control cables is effective. The following EMI suppression devices (or equivalent) are recommended:

Fair-Rite part number 0443167251 (Red Lion Controls #FCOR0000)

Line Filters for input power cables:

Schaffner # FN2010-1/07 (Red Lion Controls #LFIL0000)

6. To protect relay contacts that control inductive loads and to minimize radiated and conducted noise (EMI), some type of contact protection network is normally installed across the load, the contacts or both. The most effective location is across the load.

- a. Using a snubber, which is a resistor-capacitor (RC) network or metal oxide varistor (MOV) across an AC inductive load is very effective at reducing EMI and increasing relay contact life.
- b. If a DC inductive load (such as a DC relay coil) is controlled by a transistor switch, care must be taken not to exceed the breakdown voltage of the transistor when the load is switched. One of the most effective ways is to place a diode across the inductive load. Most Red Lion products with solid state outputs have internal zener diode protection. However external diode protection at the load is always a good design practice to limit EMI. Although the use of a snubber or varistor could be used.

Red Lion part numbers: Snubber: SNUB0000

Varistor: ILS11500 or ILS23000

7. Care should be taken when connecting input and output devices to the instrument. When a separate input and output common is provided, they should not be mixed. Therefore a sensor common should NOT be connected to an output common. This would cause EMI on the sensitive input common, which could affect the instrument's operation.

Visit <http://www.redlion.net/emi> for more information on EMI guidelines, Safety and CE issues as they relate to Red Lion products.

### WIRING OVERVIEW

Electrical connections are made via screw-clamp terminals located on the back of the meter. All conductors should conform to the meter's voltage and current ratings. All cabling should conform to appropriate standards of good installation, local codes and regulations. It is recommended that the power supplied to the meter (DC or AC) be protected by a fuse or circuit breaker.

When wiring the meter, compare the numbers embossed on the back of the meter case against those shown in wiring drawings for proper wire position. Strip the wire, leaving approximately 0.3" (7.5 mm) bare lead exposed (stranded wires should be tinned with solder.) Insert the lead under the correct screw-clamp terminal and tighten until the wire is secure. (Pull wire to verify tightness.)

### 3.1 POWER WIRING

#### Power

Terminal 1: VAC/DC +  
Terminal 2: VAC/DC -

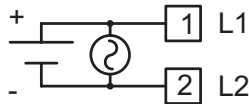

#### DC Out Power

Terminal 3: + 24 VDC  
OUT  
Terminal 4: Common

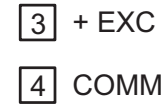

### 3.2 USER INPUT WIRING

Terminal 8: User Input  
Terminal 9: User Comm

#### Sinking Logic



#### Sourcing Logic

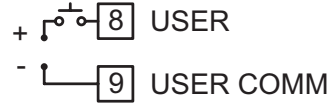

### 3.3 SETPOINT (OUTPUT) WIRING

Terminal 10: NC 1  
Terminal 11: NO 1  
Terminal 12: Relay 1 Common  
Terminal 13: NC 2  
Terminal 14: NO 2  
Terminal 15: Relay 2 Common

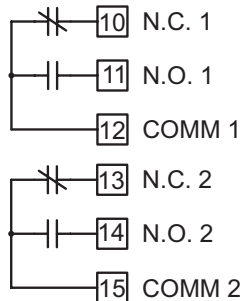

### 3.4 INPUT SIGNAL WIRING



**CAUTION:** Analog common is NOT isolated from user input common. In order to preserve the safety of the meter application, the Analog and DC power common must be suitably isolated from hazardous live earth referenced voltage; or input common must be at protective earth ground potential. If not, hazardous voltage may be present at the User Input and Input Common terminals. Appropriate considerations must then be given to the potential of the input common with respect to earth ground. Always connect the analog signal common to terminal 7.

#### Voltage Signal (self powered)

Terminal 5: +VDC  
Terminal 7: -VDC

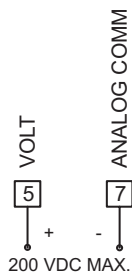

#### Current Signal (self powered)

Terminal 6: +ADC  
Terminal 7: -ADC

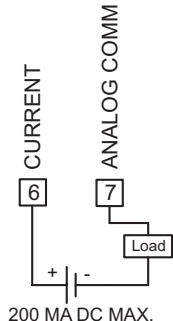

#### Current Signal (2 wire requiring excitation)

Terminal 3: +EXC  
Terminal 6: +ADC

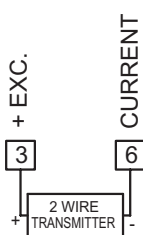

#### Current Signal (3 wire requiring excitation)

Terminal 6: +ADC (signal)  
Terminal 7: -ADC (common)  
Terminal 3: +EXC

#### Voltage Signal (3 wire requiring excitation)

Terminal 5: +VDC (signal)  
Terminal 7: -VDC (common)  
Terminal 3: +EXC

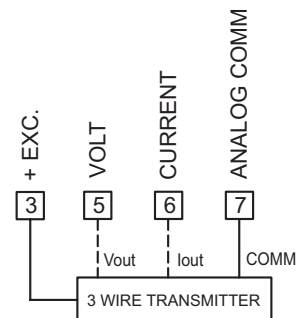

## 4.0 REVIEWING THE FRONT BUTTONS AND DISPLAY



BUTTON	DISPLAY MODE OPERATION
PAR	Access Programming Mode
SEL	Index display through selected displays
RST	Resets display

PROGRAMMING MODE OPERATION
Store selected parameter and index to next parameter
Advance through selection list/select digit position in parameter value
Increment selected digit of parameter value

### OPERATING MODE DISPLAY DESIGNATORS

MAX - Maximum display capture value  
MIN - Minimum display capture value

"SP1" - Below the display indicates setpoint 1 output activated.  
"SP2" - Below the display indicates setpoint 2 output activated.

Pressing the **SEL** button toggles the meter through the selected displays. If display scroll is enabled, the display will toggle automatically every four seconds between the enabled display values.

## 5.0 PROGRAMMING THE METER

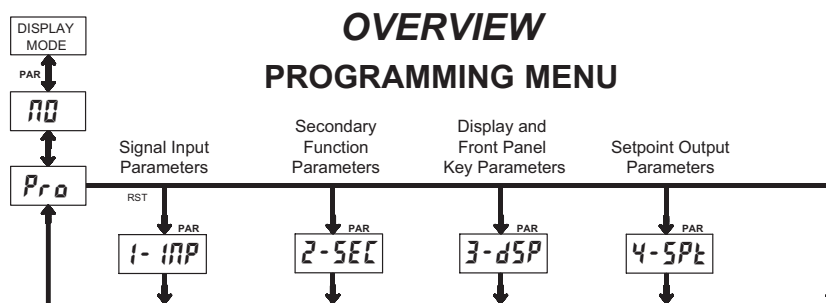

### PROGRAMMING MODE ENTRY (PAR BUTTON)

It is recommended all programming changes be made off line, or before installation. The meter normally operates in the Display Mode. No parameters can be programmed in this mode. The Programming Mode is entered by pressing the **PAR** button. If it is not accessible, then it is locked by either a security code or a hardware lock.

### MODULE ENTRY (SEL & PAR BUTTONS)

The Programming Menu is organized into four modules. These modules group together parameters that are related in function. The display will alternate between **Pr o** and the present module. The **SEL** button is used to select the desired module. The displayed module is entered by pressing the **PAR** button.

### MODULE MENU (PAR BUTTON)

Each module has a separate module menu (which is shown at the start of each module discussion). The **PAR** button is pressed to advance to a particular parameter to be changed, without changing the programming of preceding parameters. After completing a module, the display will return to **Pr o n0**. Programming may continue by accessing additional modules.

### SELECTION / VALUE ENTRY

For each parameter, the display alternates between the present parameter and the selections/value for that parameter. The **SEL** and **RST** buttons are used to move through the selections/values for that parameter. Pressing the **PAR** button, stores and activates the displayed selection/value. This also advances the meter to the next parameter.

For numeric values, the value is displayed with one digit flashing (initially the right most digit). Pressing the **RST** button increments the digit by one or the user can hold the **RST** button and the digit will automatically

scroll. The **SEL** button will select the next digit to the left. Pressing the **PAR** button will enter the value and move to the next parameter.

### PROGRAMMING MODE EXIT (PAR BUTTON)

The Programming Mode is exited by pressing the **PAR** button with **Pr o n0** displayed. This will commit any stored parameter changes to memory and return the meter to the Display Mode. (If power loss occurs before returning to the Display Mode, verify recent parameter changes.)

### PROGRAMMING TIPS

It is recommended to start with Module 1 and proceed through each module in sequence. When programming is complete, it is recommended to record the parameter programming and lock out parameter programming with the user input or programming security code.

### FACTORY SETTINGS

Factory Settings may be completely restored in Module 2. This is useful when encountering programming problems.

### ALTERNATING SELECTION DISPLAY

In the explanation of the modules, the following dual display with arrows will appear. This is used to illustrate the display alternating between the parameter on top and the parameter's Factory Setting on the bottom. In most cases, selections and values for the parameter will be listed on the right.

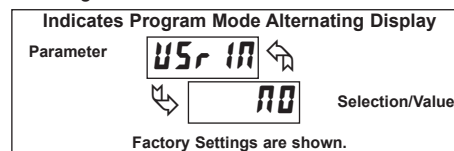

# 5.1 MODULE 1 - SIGNAL INPUT PARAMETERS (1- INP)

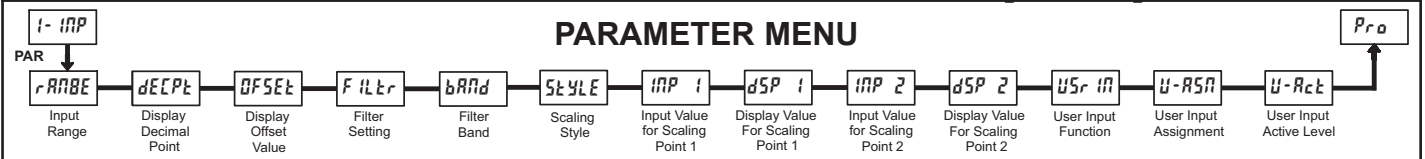

## INPUT RANGE

SELECTION	RANGE	RESOLUTION	SELECTION	RANGE	RESOLUTION
200μA	200.00	μA	0.02A	20.000	mA
0.002A	2.0000	mA	0.2A	200.00	mA
0.2V	200.00	mV	20V	20.000	V
2V	2.0000	V	200V	200.00	V
10V	10.000	V			

Select the input range that corresponds to the external signal. This selection should be high enough to avoid input signal overload but low enough for the desired input resolution. This selection and the position of the Input Range Jumper must match.

## DISPLAY DECIMAL POINT

0	0.0	0.00	0.000	0.0000	0.00000
---	-----	------	-------	--------	---------

Select the decimal point location for the Input, MIN and MAX displays. This selection also affects the *dSP 1* and *dSP 2* parameters and setpoint values and offset value..

## DISPLAY OFFSET VALUE

- 19999	to	19999
---------	----	-------

The display can be corrected with an offset value. This can be used to compensate for signal variations or sensor errors. This value is automatically updated after a Zero Display to show how far the display is offset. A value of zero will remove the effects of offset. The decimal point follows the *dECPT* selection.

## FILTER SETTING

0	1	2	3
---	---	---	---

If the displayed value is difficult to read due to small process variations or noise, increased levels of filtering will help to stabilize the display. Software filtering effectively combines a fraction of the current input reading with a fraction of the previous displayed reading to generate the new display.

Filter values represent no filtering (0), up to heavy filtering (3). A value of 1 for the filter uses 1/4 of the new input and 3/4 of the previous display to generate the new display. A filter value of 2 uses 1/8 new and 7/8 previous. A filter value of 3 uses 1/16 new and 15/16 previous.

## FILTER BAND

0	to	199	display units
---	----	-----	---------------

The filter will adapt to variations in the input signal. When the variation exceeds the input filter band value, the filter disengages. When the variation becomes less than the band value, the filter engages again. This allows for a stable readout, but permits the display to settle rapidly after a large process change. The value of the band is in display units, independent of the Display Decimal Point position. A band setting of '0' keeps the filter permanently engaged at the filter level selected above.

## SCALING STYLE

KEY	APPLY
-----	-------

If Input Values and corresponding Display Values are known, the Key-in (*KEY*) scaling style can be used. This allows scaling without the presence or changing of the input signal. If Input Values have to be derived from the actual input signal source or simulator, the Apply (*APPLY*) scaling style must be used.

## INPUT VALUE FOR SCALING POINT 1

0	to	29999
---	----	-------

For Key-in (*KEY*) style, enter the first Input Value using the front panel buttons. (The Input Range selection sets the decimal location for the Input Value).

For Apply (*APPLY*) style, the meter shows the previously stored Input Value. To retain this value, press the **SEL** button to advance to the next parameter. To change the Input Value, press the **RST** button and apply the input signal to the meter. Adjust the signal source externally until the desired Input Value appears. Press the **SEL** button to enter the value being displayed.

## DISPLAY VALUE FOR SCALING POINT 1

- 19999	to	99999
---------	----	-------

Enter the first Display Value by using the front panel buttons. This is the same for *KEY* and *APPLY* scaling styles. The decimal point follows the *dECPT* selection.

## INPUT VALUE FOR SCALING POINT 2

0	to	29999
---	----	-------

For Key-in (*KEY*) style, enter the known second Input Value using the front panel buttons.

For Apply (*APPLY*) style, the meter shows the previously stored Input Value for Scaling Point 2. To retain this value, press the **SEL** button to advance to the next parameter. To change the Input Value, press the **RST** button and apply the input signal to the meter. Adjust the signal source externally until the desired Input Value appears. Press the **SEL** button to enter the value being displayed.

## DISPLAY VALUE FOR SCALING POINT 2

- 19999	to	99999
---------	----	-------

Enter the second Display Value by using the front panel buttons. This is the same for *KEY* and *APPLY* scaling styles. The decimal point follows the *dECPT* selection.

## General Notes on Scaling

1. When using the Apply (*APPLY*) scaling style, input values for scaling points must be confined to the range limits shown.
2. The same Input Value should not correspond to more than one Display Value. (Example: 20 mA can not equal 0 and 20.)
3. For input levels beyond the programmed Input Values, the meter extends the Display Value by calculating the slope from the two coordinate pairs (*INP 1* / *dSP 1* & *INP 2* / *dSP 2*).

### USER INPUT FUNCTION

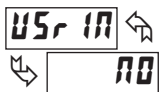

DISPLAY	MODE	DESCRIPTION
<b>NO</b>	No Function	User Input disabled.
<b>P-Loc</b>	Program Mode Lock-out	See Programming Mode Access chart (Module 3).
<b>ZEr0</b>	Zero Input (Edge triggered)	Zero the Input Display value causing Display Reading to be Offset.
<b>rESEt</b>	Reset (Edge triggered)	Resets the assigned value(s) to the current input value.
<b>d-HLd</b>	Display Hold	Holds the assigned display, but all other meter functions continue as long as activated (maintained action).
<b>d-SEL</b>	Display Select (Edge Triggered)	Advance once for each activation.
<b>d-LEU</b>	Display Intensity Level (Edge Triggered)	Increase intensity one level for each activation.
<b>rSt-1</b>	Setpoint 1 Reset	Resets setpoint 1 output.
<b>rSt-2</b>	Setpoint 2 Reset	Resets setpoint 2 output.
<b>rSt-12</b>	Setpoint 1 and 2 Reset	Reset both setpoint 1 and 2 outputs.

### USER INPUT ASSIGNMENT

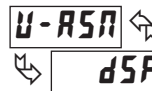

HI HI-LO  
LO dSP

Select the value(s) to which the User Input Function is assigned. The User Input Assignment only applies if a selection of reset, or display hold is selected in the User Input Function menu.

### USER INPUT ACTIVE LEVEL



HI LO

Select whether the user input is configured as active low or active high.

## 5.2 MODULE 2 - SECONDARY FUNCTION PARAMETERS (2-5EE)

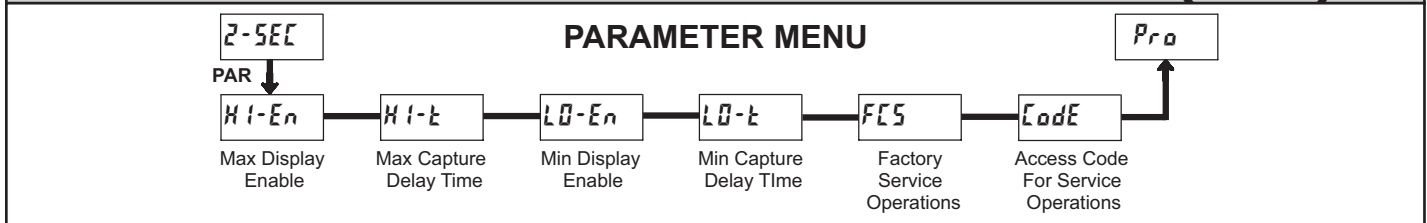

### MAX DISPLAY ENABLE

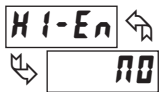

NO YES

Enables the Maximum Display Capture capability.

### MAX CAPTURE DELAY TIME

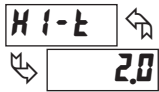

0.0 to 999.9 sec.

When the Input Display is above the present MAX value for the entered delay time, the meter will capture that display value as the new MAX reading. A delay time helps to avoid false captures of sudden short spikes.

### MIN DISPLAY ENABLE

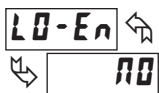

NO YES

Enables the Minimum Display Capture capability.

### MIN CAPTURE DELAY TIME

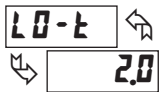

0.0 to 999.9 sec.

When the Input Display is below the present MIN value for the entered delay time, the meter will capture that display value as the new MIN reading. A delay time helps to avoid false captures of sudden short spikes.

### FACTORY SERVICE OPERATIONS



NO YES

Select YES to perform any of the Factory Service Operations shown below.

### RESTORE FACTORY DEFAULT SETTINGS

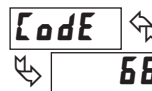

Entering Code 66 will overwrite all user settings with the factory settings. The meter will display rESEt and then return to CodE 00. Press the PAR button to exit the module.

### VIEW MODEL AND VERSION DISPLAY

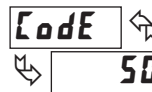

Entering Code 50 will display the version (x.x) of the meter. The display then returns to CodE 00. Press the PAR button to exit the module.

### CALIBRATION

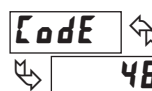

The PAXLA uses stored calibration values to provide accurate measurements. Over time, the electrical characteristics of the components inside the PAXLA will slowly change, resulting in the stored calibration values no longer accurately defining the input circuit.

For most applications, recalibration every 1 to 2 years should be sufficient.

Calibration of the PAXLA involves a calibration which should only be performed by individuals experienced in calibrating electronic equipment. Allow 30 minute warm up before performing any calibration related procedure. The following procedures should be performed at an ambient temperature of 15 to 35 °C (59 to 95 °F).

**CAUTION:** The accuracy of the calibration equipment will directly affect the accuracy of the PAXLA.

### Current Calibration

1. Connect the negative lead of a precision DC current source with an accuracy of 0.01% or better to the COMM terminal. Leave the positive lead of the DC current source unconnected.
2. With the display at **Code 48**, press the **PAR** button. Unit will display **RL NO**
3. Press the **RST** button to select the range to be calibrated.
4. Press the **PAR** button. Display reads **0.00**
5. With the positive lead of the DC current source unconnected, press **PAR**. Display reads **RL L** for about 8 seconds.
6. When the display reads the selected range, connect the positive lead of the DC current source to the current input and apply full-scale input signal for the range. (Note: For 200 mA range, apply 100 mA as indicated on the display.) Press **PAR**. Display reads **RL L** for about 8 seconds.
7. Repeat steps 3 through 6 for each input range to be calibrated. When display reads **RL NO**, press the **PAR** button to exit calibration.

### Voltage Calibration

1. Connect a precision DC voltage source with an accuracy of 0.01% or better to the volt input and COMM terminals of the PAXLA. Set the output of the voltage source to zero.
2. With the display at **Code 48**, press the **PAR** button. Unit will display **RL NO**.
3. Press the **RST** button to select the range to be calibrated.
4. Press the **PAR** button. Display reads **0.00**.
5. With the voltage source set to zero (or a dead short applied to the input), press **PAR**. Display reads **RL L** for about 8 seconds.
6. When the display reads the selected range, apply full-scale input signal for the range. (Note: For 200V range, apply 100V as indicated on the display.) Press **PAR**. Display reads **RL L** for about 8 seconds.
7. Repeat steps 3 through 6 for each input range to be calibrated. When display reads **RL NO**, press the **PAR** button to exit calibration

## 5.3 MODULE 3 - DISPLAY AND FRONT PANEL BUTTON PARAMETERS (3-dSP)

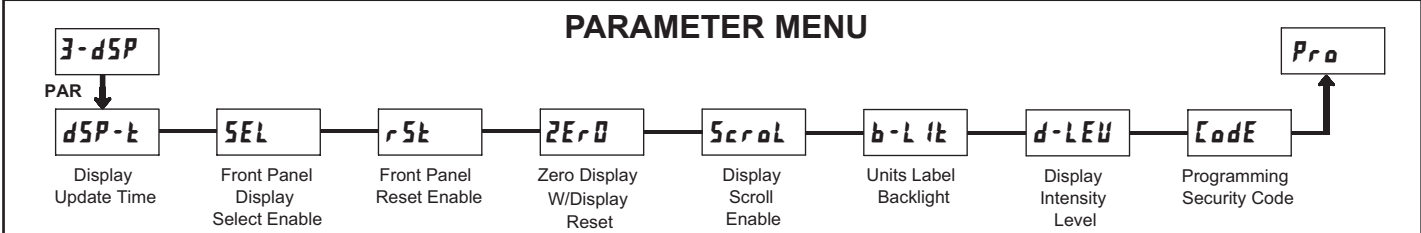

#### DISPLAY UPDATE TIME

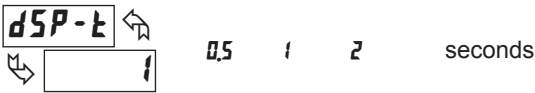

This parameter sets the display update time in seconds.

#### FRONT PANEL DISPLAY SELECT ENABLE (SEL)



The **YES** selection allows the **SEL** button to toggle through the enabled displays.

#### FRONT PANEL RESET ENABLE (RST)



This selection allows the **RST** button to reset the selected value(s).

#### ZERO DISPLAY WITH DISPLAY RESET



This parameter enables the **RST** button or user input to zero the input display value, causing the display reading to be offset.

Note: For this parameter to operate, the **RST** button or User Input being used must be set to **dSP** and the Input value must be displayed. If these conditions are not met, the display will not zero.

#### DISPLAY SCROLL ENABLE



The **YES** selection allows the display to automatically scroll through the enabled displays. The scroll rate is every 4 seconds. This parameter only appears when the MAX or MIN displays are enabled.

#### UNITS LABEL BACKLIGHT\*



The Units Label Kit Accessory contains a sheet of custom unit overlays which can be installed in to the meter's bezel display assembly. The backlight for these custom units is activated by this parameter.

#### DISPLAY INTENSITY LEVEL



Enter the desired Display Intensity Level (1-3). The display will actively dim or brighten as levels are changed.



**PROGRAMMING SECURITY CODE**



000 to 999

The Security Code determines the programming mode and the accessibility of programming parameters. This code can be used along with the Program Mode Lock-out (P-Loc) in the User Input Function parameter (Module 1).

Two programming modes are available. Full Programming mode allows all parameters to be viewed and modified. Quick Programming mode permits only the Setpoint values to be modified, but allows direct access to these values without having to enter Full Programming mode.

Programming a Security Code other than 0, requires this code to be entered at the **Code** prompt in order to access Full Programming mode. Depending on the code value, Quick Programming may be accessible before the **Code** prompt appears (see chart).

USER INPUT FUNCTION	USER INPUT STATE	SECURITY CODE	MODE WHEN "PAR" BUTTON IS PRESSED	FULL PROGRAMMING MODE ACCESS
not P-Loc	_____	0	Full Programming	Immediate Access
		1-99	Quick Programming	After Quick Programming with correct code entry at <b>Code</b> prompt *
		100-999	<b>Code</b> prompt	With correct code entry at <b>Code</b> prompt *
P-Loc	Active	0	Programming Lock	No Access
		1-99	Quick Programming	No Access
		100-999	<b>Code</b> prompt	With correct code entry at <b>Code</b> prompt *
	Not Active	0-999	Full Programming	Immediate Access

\* Entering Code 222 allows access regardless of security code.

**5.4 MODULE 4 - SETPOINT OUTPUT PARAMETERS (4-SPt)**

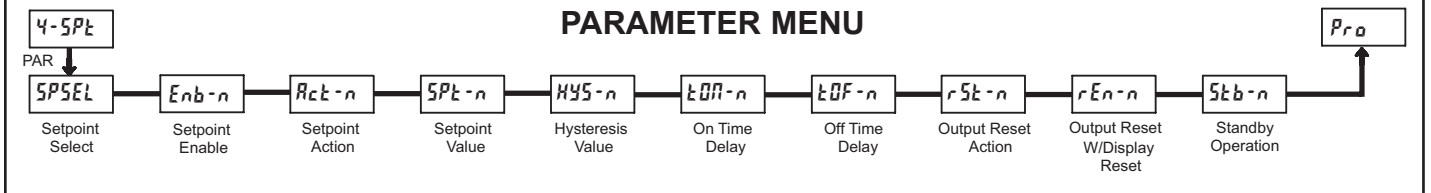

**SETPOINT SELECT**



no SP-1 SP-2

Enter the setpoint (output) to be programmed. The *n* in the following parameters will reflect the chosen setpoint number. After the chosen setpoint is completely programmed, the display will return to **SPSEL**. Repeat steps for each setpoint to be programmed. Select **no** to exit the module.

**SETPOINT ENABLE**

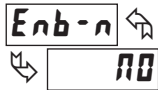

yes no

Select **yes** to enable Setpoint *n* and access the setup parameters. If **no** is selected, the unit returns to **SPSEL** and Setpoint *n* is disabled.

**SETPOINT ACTION**

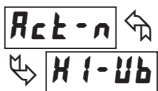

HI-bL LO-bL HI-Ub LO-Ub

Enter the action for the selected setpoint (output). See Setpoint Output Figures for a visual detail of each action.

- HI-bL = High Acting, with balanced hysteresis
- LO-bL = Low Acting, with balanced hysteresis
- HI-Ub = High Acting, with unbalanced hysteresis
- LO-Ub = Low Acting, with unbalanced hysteresis

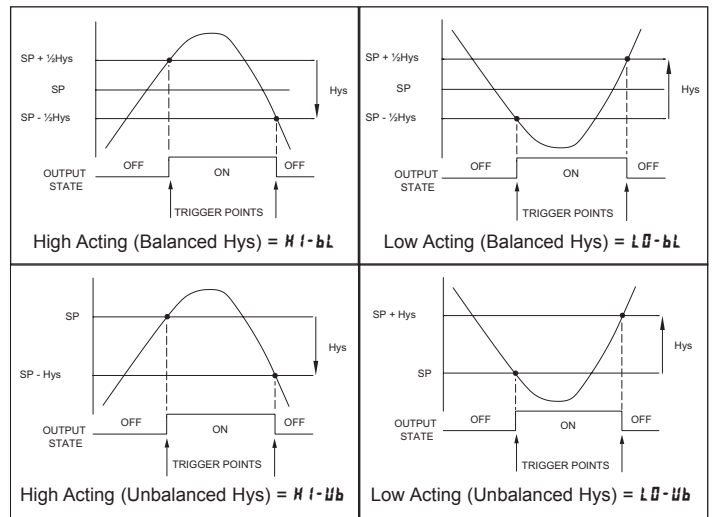

**SETPOINT VALUE**



- 19999 to 99999

Enter the desired setpoint value. The decimal point position for the setpoint and hysteresis values follow the selection set in Module 1.

### HYSTERESIS VALUE

**HYS-n** ↩  
 ↪

1 to 59999

Enter desired hysteresis value. See Setpoint Output Figures for visual explanation of how setpoint output actions (balanced and unbalanced) are affected by the hysteresis. When the setpoint is a control output, usually balanced hysteresis is used. For alarm applications, usually unbalanced hysteresis is used. For unbalanced hysteresis modes, the hysteresis functions on the low side for high acting setpoints and functions on the high side for low acting setpoints.

*Note: Hysteresis eliminates output chatter at the switch point, while time delay can be used to prevent false triggering during process transient events.*

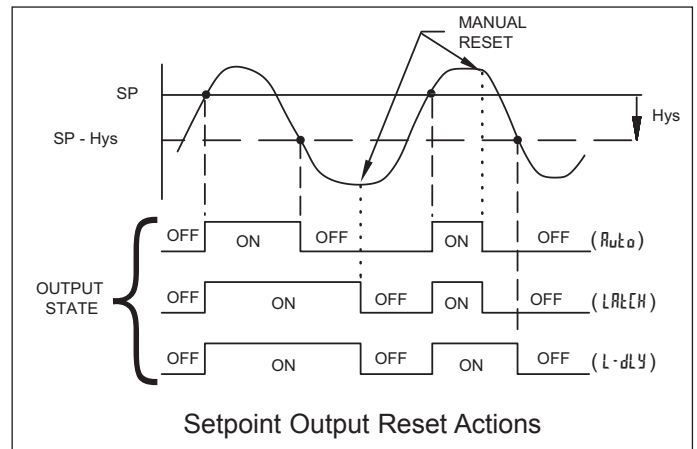

### ON TIME DELAY

**TON-n** ↩  
 ↪

0.0 to 5999 Sec

Enter the time value in seconds that the output is delayed from turning on after the trigger point is reached. A value of 0.0 allows the meter to update the output status per the response time listed in the Specifications.

### OFF TIME DELAY

**TOF-n** ↩  
 ↪

0.0 to 5999 Sec

Enter the time value in seconds that the output is delayed from turning off after the trigger point is reached. A value of 0.0 allows the meter to update the output status per the response time listed in the Specifications.

### OUTPUT RESET ACTION

**rSt-n** ↩  
 ↪

Auto LATCH L-DLY

Enter the reset action of the output. See figure for details.

**Auto** = Automatic action; This action allows the output to automatically reset off at the trigger points per the Setpoint Action shown in Setpoint Output Figures. The "on" output may be manually reset (off) immediately by the front panel **RST** button or user input. The output remains off until the trigger point is crossed again.

**LATCH** = Latch with immediate reset action; This action latches the output on at the trigger point per the Setpoint Action shown in Setpoint Output Figures. Latch means that the output can only be turned off by the front panel **RST** button or user input manual reset, or meter power cycle. When the user input or **RST** button is activated (momentary action), the corresponding "on" output is reset immediately and remains off until the trigger point is crossed again. (Previously latched alarms will be off if power up Display Value is lower than setpoint value.)

**L-DLY** = Latch with delay reset action; This action latches the output on at the trigger point per the Setpoint Action shown in Setpoint Output Figures. Latch means that the output can only be turned off by the front panel **RST** button or user input manual reset, or meter power cycle. When the user input or **RST** button is activated (momentary action), the meter delays the event until the corresponding "on" output crosses the trigger off point. (Previously latched outputs are off if power up Display Value is lower than setpoint value. During a power cycle, the meter erases a previous **L-DLY** reset if it is not activated at power up.)

### OUTPUT RESET WITH DISPLAY RESET

**rEn-n** ↩  
 ↪

NO YES

This parameter enables the **RST** button or user input to reset the output when the display is reset.

*Note: For this parameter to operate, the **RST** button or User Input being used must be set to **dSP** and the Input value must be displayed. If these conditions are not met, the output will not reset.*

### STANDBY OPERATION

**Stb-n** ↩  
 ↪

NO YES

When **YES**, the output is disabled (after a power up) until the trigger point is crossed. Once the output is on, the output operates normally per the Setpoint Action and Output Reset Action.

# PAXLA PROGRAMMING QUICK OVERVIEW

Press **PAR** key to enter Programming Mode.

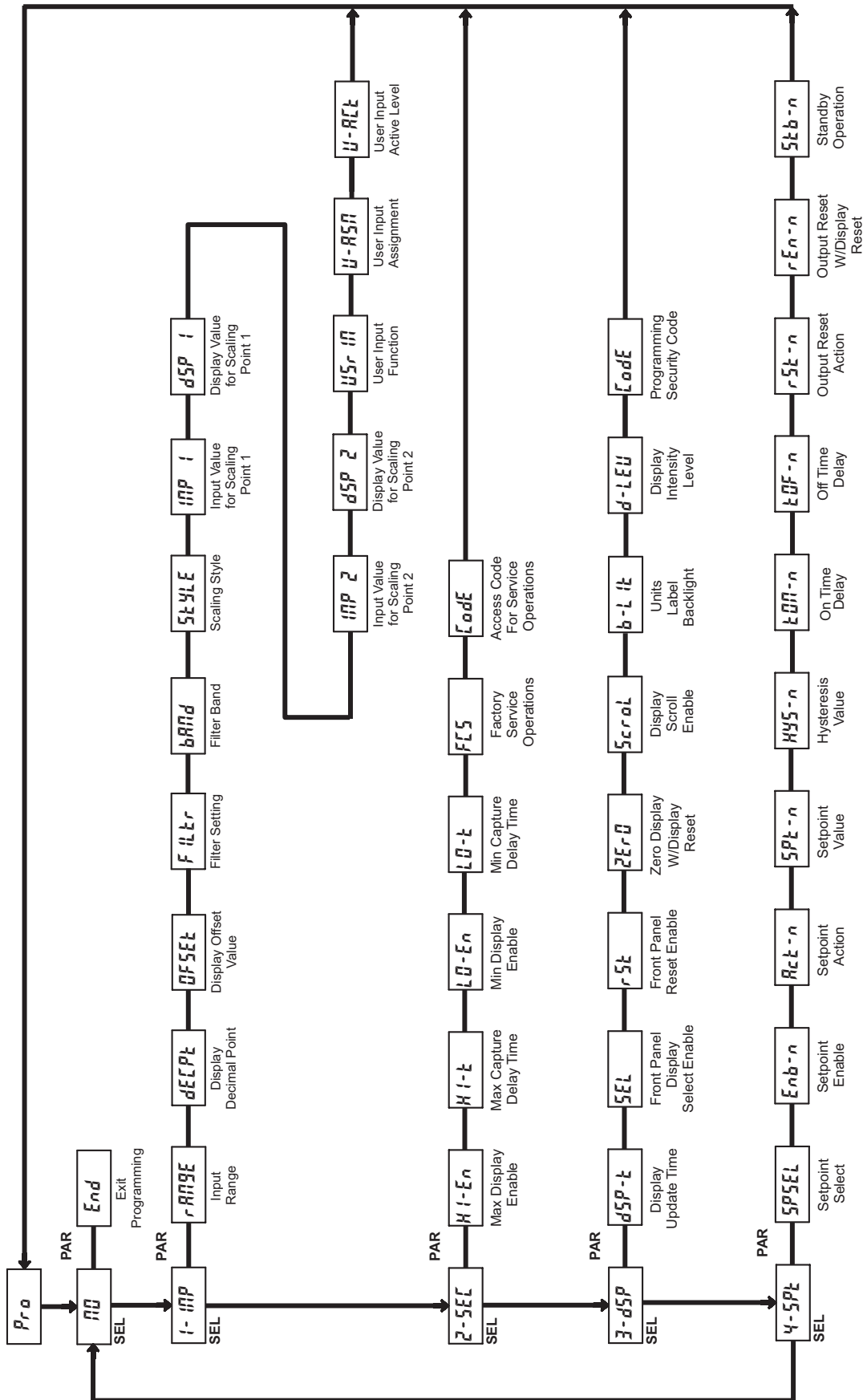

**LIMITED WARRANTY**

(a) Red Lion Controls Inc., (the "Company") warrants that all Products shall be free from defects in material and workmanship under normal use for the period of time provided in "Statement of Warranty Periods" (available at [www.redlion.net](http://www.redlion.net)) current at the time of shipment of the Products (the "Warranty Period"). **EXCEPT FOR THE ABOVE-STATED WARRANTY, COMPANY MAKES NO WARRANTY WHATSOEVER WITH RESPECT TO THE PRODUCTS, INCLUDING ANY (A) WARRANTY OF MERCHANTABILITY; (B) WARRANTY OF FITNESS FOR A PARTICULAR PURPOSE; OR (C) WARRANTY AGAINST INFRINGEMENT OF INTELLECTUAL PROPERTY RIGHTS OF A THIRD PARTY; WHETHER EXPRESS OR IMPLIED BY LAW, COURSE OF DEALING, COURSE OF PERFORMANCE, USAGE OF TRADE OR OTHERWISE.** Customer shall be responsible for determining that a Product is suitable for Customer's use and that such use complies with any applicable local, state or federal law.

(b) The Company shall not be liable for a breach of the warranty set forth in paragraph (a) if (i) the defect is a result of Customer's failure to store, install, commission or maintain the Product according to specifications; (ii) Customer alters or repairs such Product without the prior written consent of Company.

(c) Subject to paragraph (b), with respect to any such Product during the Warranty Period, Company shall, in its sole discretion, either (i) repair or replace the Product; or (ii) credit or refund the price of Product provided that, if Company so requests, Customer shall, at Company's expense, return such Product to Company.

(d) **THE REMEDIES SET FORTH IN PARAGRAPH (c) SHALL BE THE CUSTOMER'S SOLE AND EXCLUSIVE REMEDY AND COMPANY'S ENTIRE LIABILITY FOR ANY BREACH OF THE LIMITED WARRANTY SET FORTH IN PARAGRAPH (a).**